



# TYPICAL

---

## GC6717MD-B10

DIRECT DRIVE LOCKSTITCH SEWING  
MACHINE WITH SIDE CUTTER

PARTS CATALOGUE

- Besides adjusting stitch, please laypeople don't debug or maintain.
- Parts are subject to changes in design without prior notice.

**XI'AN TYPICAL INDUSTRIES CO.,LTD.**











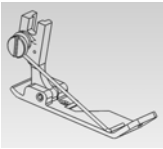
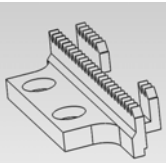
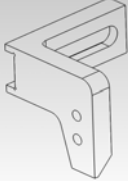
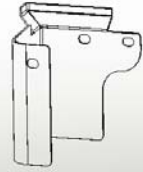
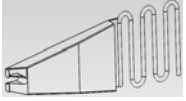

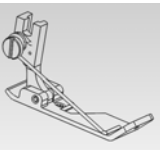
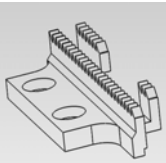
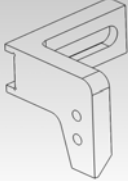
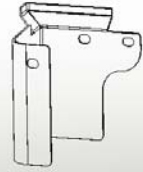
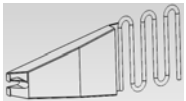

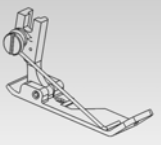
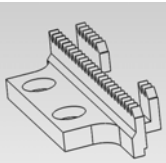
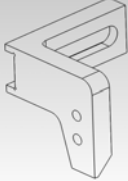
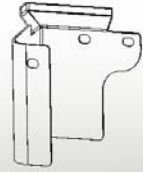
---

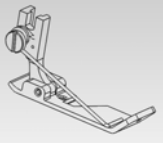
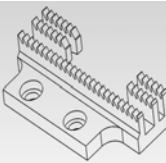
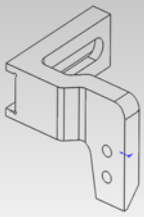
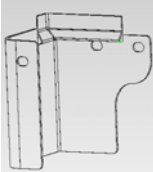
Add: No.335 Taibai South Road,  
Xi'an, P.R. China-710068  
Tel: +86-29-88279091 88279150  
Fax: +86-29-88279715 88275215  
E-mail: typical@chinatypical.com  
[Http://www.chinatypical.com](http://www.chinatypical.com)  
[Http://www.chinatypical.com](http://www.chinatypical.com)

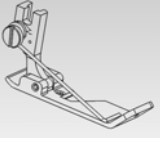
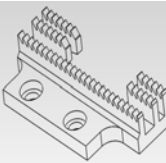
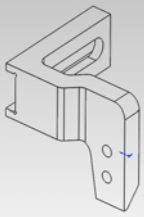
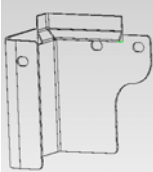
---

XI'AN TYPICAL INDUSTRIES CO.,LTD.

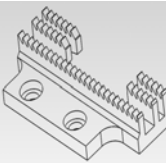
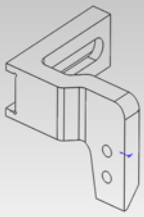
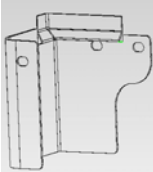
## 6717MD-B10 Specifications of Configuration Table

6mm	 258G00005 4.8mm	 258G50000	 258G00002	 258G00001	 258H00027	 24mm
6.5mm	 258G00028 5.5mm	 258G60000	 258G00002	 258G00001	 258H00027	 26mm
7mm	 258G00013 6mm	 258G40000	 258G00002	 258G00001	 258H00027	 28mm
8mm	 258H02001 7mm	 258H03000	 258H00021	 258H00020	 258H00028	 32mm
9mm	 258H02002 8mm	 258H04000	 258H00021	 258H00020	 258H00028	 36mm
10mm	 258H02003 9mm	 258H05000	 258H00021	 258H00020	 258H00028	 40mm

# Special parts for (1)

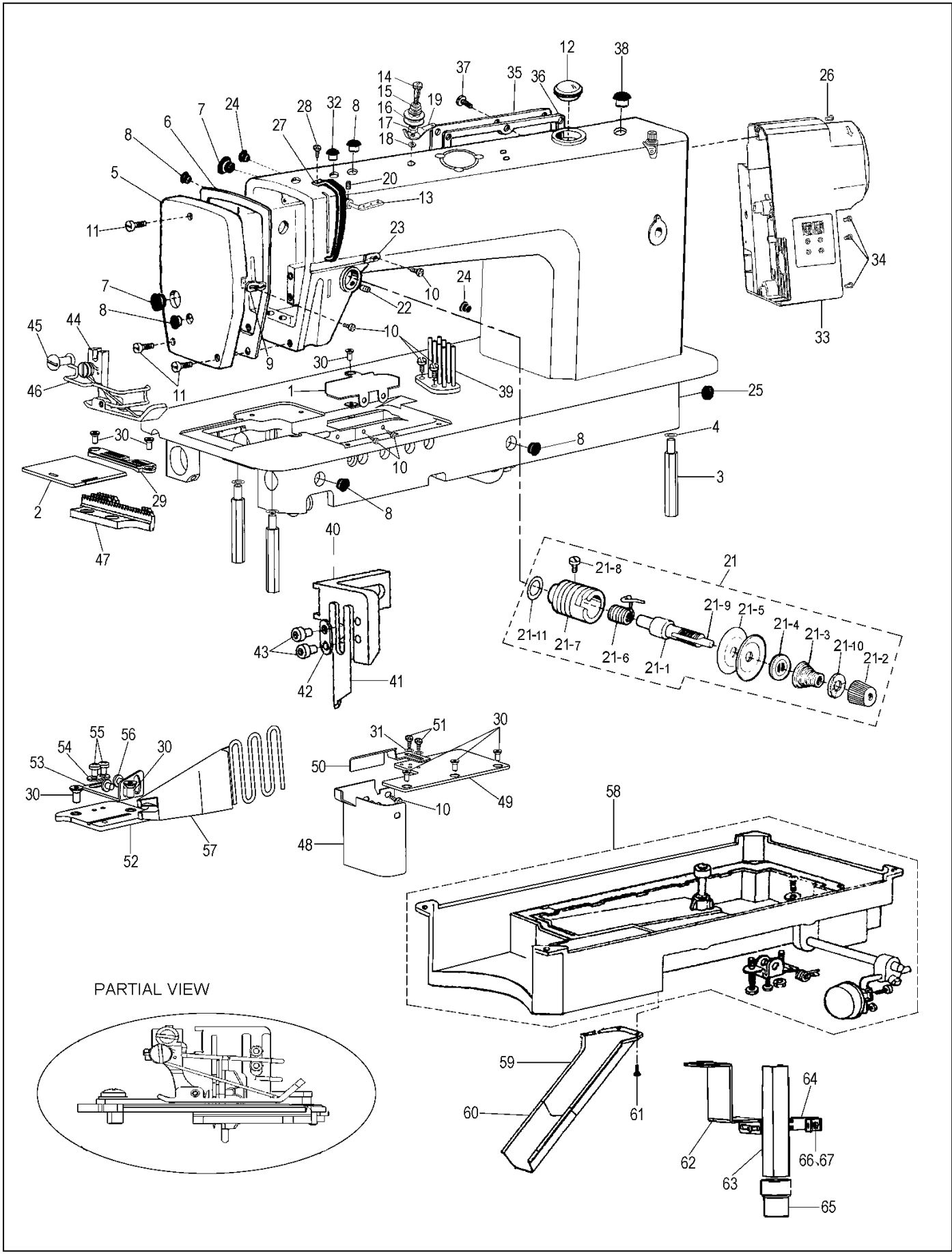

## Special parts for (1)

No.	Ref.No.	Description	Qt	Remark
1	258H00024	Case cover	1	
2	258H00022	Slide plate	1	
3	048100005	Support rod	3	
4	S150601004	Spring washer	3	
5	258100001	Face plate	1	
6	258100002	Face plate gasket	1	
7	022130003 - - v	Rubber plug ( 19)	2	
8	022130004 - - v	Rubber plug ( 11.8)	5	
9	022130005	Thread guide on face plate	1	
10	022130006	Screw	8	
11	022100004	Screw	3	
12	022180001 - - v	Oil check window	1	
13	022100010	Three hole thread guide	1	
14	022150001	Screw	1	
15	022150002	Spring	1	
16	022150003	Thread tension disc	1	
17	022150004	Padding block	2	
18	S150620001	Lock washer	1	
19	022150005	Tension bracket	1	
20	022100011 - - d	Setting screw	1	
21	124130000 - - w	Tension thread retainer assy	1	
21 - 1	022160001	Screw	1	
21 - 2	124130001 - - w	Thread tension nut	1	
21 - 3	124130002	Thread tension spring	1	
21 - 4	022160004	Thread tension releasing disc	1	
21 - 5	022160005	Thread tension disc	2	
21 - 6	022160006	Thread take - up spring	1	
21 - 7	022160007	Thread tension regulator bushing	1	
21 - 8	022160008	Screw	1	
21 - 9	238100004	Thread tension rleasing pin	1	
21 - 10	022160010	Stop disc	1	
21 - 11	022160011	O - type ring	1	
22	022100013 - - d	Set screw	1	
23	022100014	Thread guide	1	
24	022100015 - - v	Rubber plug ( 8.8)	4	
25	022100016	Rubber plug ( 27)	1	
26	S150216033	Screw M5X25	2	
27	BXF9768001 - w	Thread take - up lever guard	1	
28	022200004 - - d	Screw	1	
29	258G00005	Needle plate (4.8mm)	1	
	258G00013	Needle plate (6mm)	1	
	258H02001	Needle plate (7mm)	1	
	258H02002	Needle plate (8mm)	1	
	258H02003	Needle plate (9mm)	1	
30	022100020	Screw	8	

# Special parts for (1)

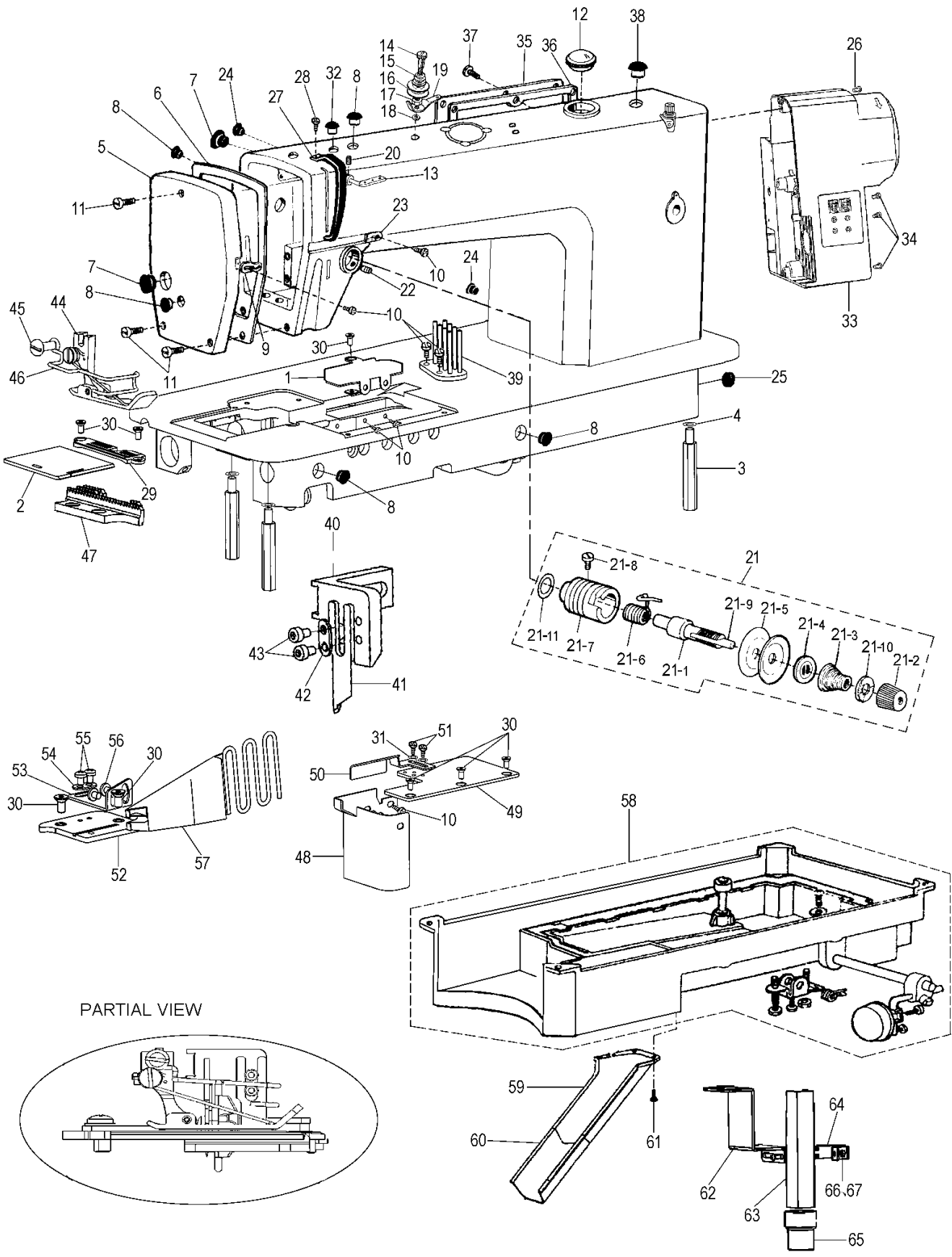

## Special parts for (1)

No.	Ref.No.	Description	Qt	Remark
31	S150607007	Washer GB97 - 76 3	2	
32	022100017 - - v	Rubber plug ( 5.7)	1	
33	258510000	Controller assy	1	
34	S150237001	Screw M5X18	3	
35	022140001 - - w	Side plate	1	
36	022140002	Washer	1	
37	022100006	Screw	8	
38	230100019	Rubber plug ( 15.5)	1	
39	258H00001	Mounting plate assy	1	
40	258G00001	Cut tool holder (With small size)	1	
	258H00020	Cut tool holder (With large size)	1	
41	258G00016	Cutter	1	
42	029800025	Upper knife presser	1	
43	036710006	Screw	1	
44	258G50000	Presser foot assy ( With 4.8mm needle plate )	1	
	258G40000	Presser foot assy ( With 6mm needle plate )	1	
	258H03000	Presser foot assy ( With 7mm needle plate )	1	
	258H04000	Presser foot assy ( With 8mm needle plate )	1	
	258H05000	Presser foot assy ( With 9mm needle plate )	1	
45	022700015	Presser foot screws	1	
46	258G00020	Finger guard	1	
47	258G00002	Feed dog	1	
	258H00021	Feed dog	1	
48	258H00027	Discharge hopper plate (With small size)	1	
	258H00028	Discharge hopper plate (With large size)	1	
49	258H00025	Material guide cover	1	
50	258H00026	Material guide plate	1	
51	S150216011	Screw GB818 - 85 M3 x 6	2	
52	258H00023	Needle plate guide plate	1	
53	258H00032	Supporting board	1	
54	258G00011	Washer	1	
55	B048600494	Screw M4 x 6	2	
56	S150216053	Screw M4 x 4	1	
57	258G00007	Edge fomer (24mm)	1	
	258G00014	Edge fomer (28mm)	1	
	258H00029	Edge fomer (32mm)	1	
	258H00030	Edge fomer (36mm)	1	
	258H00031	Edge fomer (40mm)	1	
58	258H06000	Oil reservoir assy	1	
59	258H00015	Chip removal chutes ( big )	1	
60	258H00016	Chip removal chutes ( small )	1	
61	S150299031	Screw M4 x 10 GB818 - 85	4	

Special parts for (2)

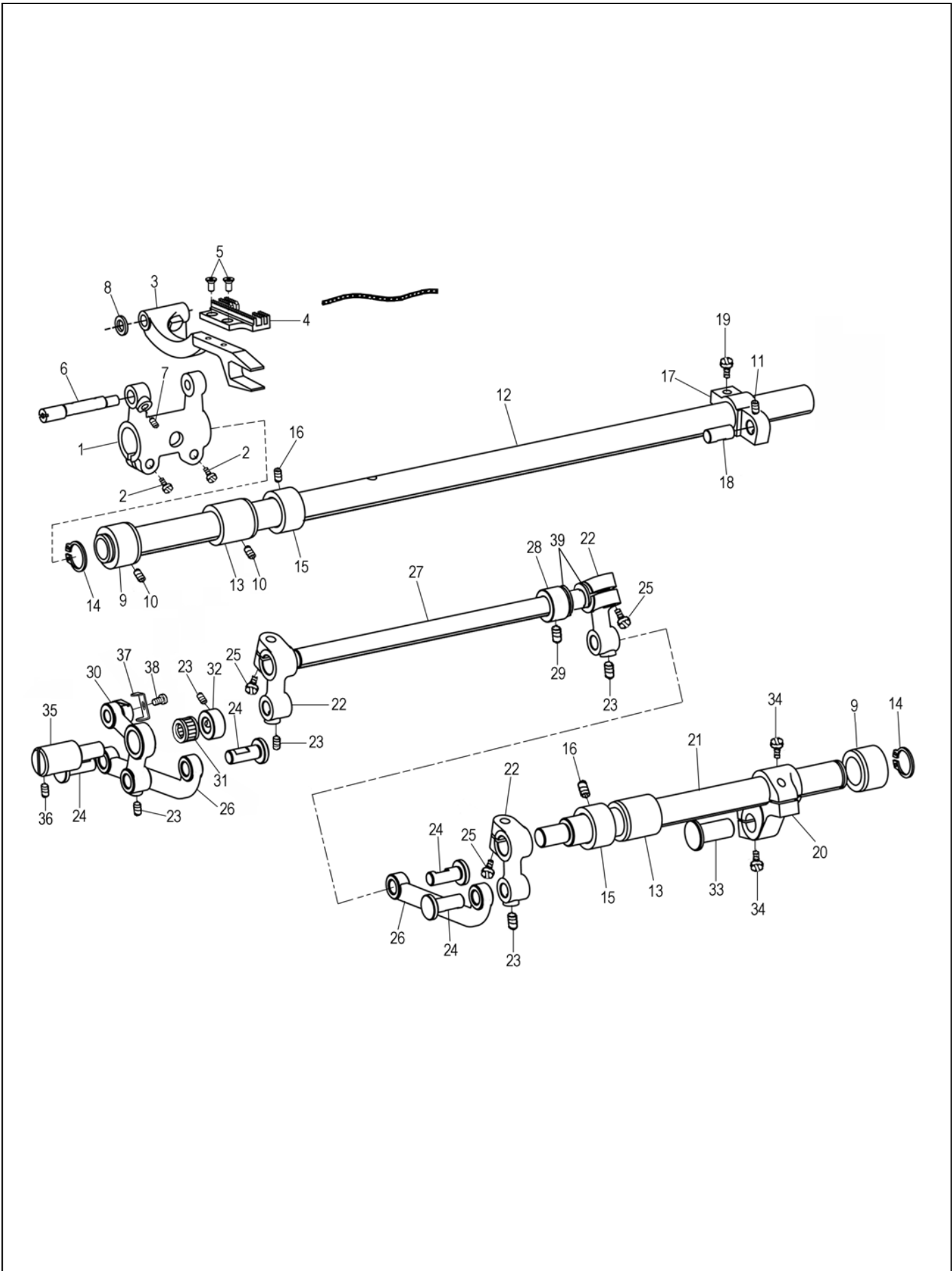

Special parts for (2)

No.	Ref.No.	Description	Qt	Remark
1	022611001	Feed rock shaft crank	1	
2	022612001	Screw	2	
3	258H00002	Feed bar	1	
4	258G00002	Feed dog ( Two rows of teeth )	1	
	258H00021	Feed dog ( Three rows of teeth )	1	
5	022610004	Screw	2	
6	036410002	Shaft for feed bar	1	
7	022200019	Screw	1	
8	022610006	Washer	1	
9	258H00003	Bushing for feed rock shaft ( left )	2	
10	022200009	Screw	2	
11	036550005	Screw	1	
12	258H00005	Feed rock shaft	1	
13	022600004	Bushing for feed rock shaft	2	
14	S150617006	C-type stop ring 15	2	
15	022620001	Shrink-ring	2	
16	022320002	Screw	4	
17	036400003	Feed rock shaft crank(right)	1	
18	036400204	Pin	1	
19	022640003	Screw	1	
20	036400017	Feed lifting rock shaft crank(right)	1	
21	258H00006	Feed lifting rock shaft	1	
22	258H00007	Adjusting crank ( left )	3	
23	B096420488	Screw SM11/64x40x6	6	
24	258H00008	Pin	4	
25	B048349498	Screw SM15/64x28x16	3	
26	258H00009	Link	2	
27	258H00010	Crank shaft	1	
28	036780001	Collar	1	
29	022320002	Screw	1	
30	258H00012	Crank for feed lifting rock shaft assy	1	
31	S150801029	Needle roller bearings K081208	1	
32	258H00011	Shrink-ring	1	
33	022600007	Hinge pin	1	
34	022600016	Screw	2	
35	258H00013	Shaft	1	
36	022200002	Screw	1	
37	258H00033	Oil Clamps	1	
38	S150216011	Screw GB818-76 3X6	1	
39	BX80754009	Washer $\Phi 10 \times \Phi 18 \times 1$	2	